

AGNEUS AGPC1040S Dimmer Light Controller Plus

12V/24V 10A PWM Solar Battery Charger / Street Light controller
User's Manual
READ BEFORE TO INSTALL



General Safety Recommendations



1. Batteries stores a large amount of energy. **Under all circumstances, never short circuit a Battery. We recommend connecting a fuse directly to the positive battery terminal**, adjusted to the maximum intensity of use and without overpass the nominal intensity of AGNEUS Regulator.
2. **Batteries can produce flammable gases.** Avoid making sparks using fire or any naked flame. Be sure that the battery room is ventilated.
3. **Avoid touching or short circuiting wires or terminals.** Use isolated tools, remains always in dry floor and keep your hands dry.
4. **Keep children away** from batteries and the charge regulator.
5. Please, observe the safety recommendations of the battery manufacturer. If you have any doubt, consult your seller or installer.

Intended Use

The charge regulator is designed to be used in a isolated photovoltaic system for a Lead-acid battery with **12V or 24V of nominal voltage** and **pulsed dimming lamps**. Deep charge algorithm is optimized for VRLA and GEL battery.

Liability Exclusion

The manufacturer shall not be able for damages, especially on the battery, caused by use other than as intended or as mentioned in this manual, or if the recommendations of the battery manufacturer are neglected. The manufacturer shall not be liable if there has been service or repair carried out by any unauthorized person, unusual use, wrong installation or bad system design. Opening case voids warranty.

General Description

The battery charge regulator AGNEUS AGPC1040S is a PWM shunt lead acid battery Solar charger. Automatically detects the nominal voltage of the battery (12V or 24V) and makes an active control of charge current till reach a maximum of 10A of output current.

Moreover, it makes an active control of photovoltaic module and loads, to protect battery from overcharge and extended uses without finishing a deep battery charge or equalization charge.

Dimmer Light Controller: Lights are automatically started at sunset and remains on during 6h minimum till sunrise.



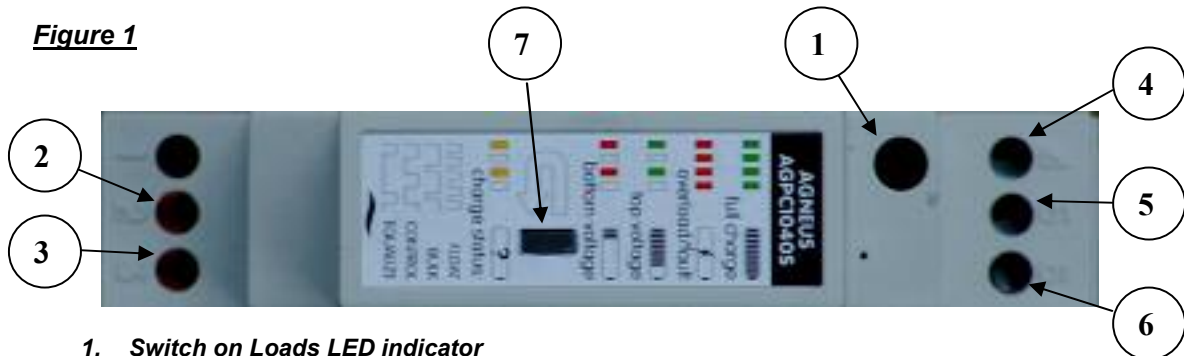

Luminosity is dimming 50% by applying 1ms square pulses and following a sophisticated algorithm as function of battery state and hours of night duration. At page 3 is explained the functionality in different profiles of real cases.

Figure 1



1. **Switch on Loads LED indicator**
2. **Positive of Photovoltaic module PV+**
3. **Negative of Photovoltaic module PV-**
4. **Positive of the output for user's loads OUT+**
5. **Positive of battery BAT+**
6. **Negative of battery BAT-**
7. **Battery State LED indicator: alternate 1 minute function charge status / battery condition**

ORANGE blink:
CHARGE STATUS

 FLOAT
 BULK
 CONTROL
 EQUALIZE

Fast GREEN blink:
PWM CHARGE MODE

GREEN blink: Top battery voltage
 RED blink: Bottom battery voltage
 GREEN ON: Battery full charged
 RED ON: Overload / Fault

Installation and connection (see figures 1 and 2)

Protects the regulator from direct sun light and rain and place it in a dry and non flammable surface (the regulator warms up during operation). The distance between the regulator and the battery should be as short as possible, always below 1m length. Use wires of $2,5\text{mm}^2$ of maximum thickness.

Between regulator output OUT+ (4) and loads positive side (24V luminaries, for example), we will insert the switch breaker, as shown in the figure 2. User loads negative side will connect directly to the battery negative terminal.

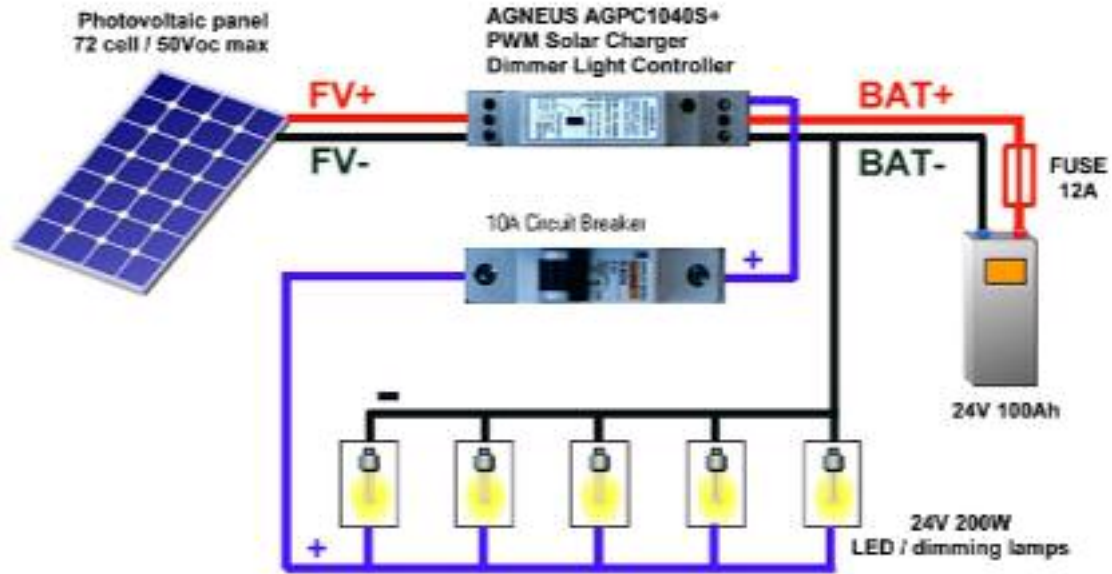

Before begin to install, be sure that battery is not connected!



1. Install the electric enclosure and inserts the regulator and the switch breaker in the DIN RAIL.
2. Connect the regulator output terminal OUT+ (4) at switch breaker nearest terminal. Be sure that the switch lever is at OFF position. Connect the other switch breaker terminal to the positive side of your desired loads to be supplied.
3. **With battery unconnected**, insert the positive wire of battery BAT+ to the regulator terminal (5). After, insert the negative wire BAT- to the regulator terminal (6).
4. Now proceed to make the battery connections. **Attention! If inverts the battery polarity, could be produced irreparable damages over the regulator.**
5. Connect the positive wire of the photovoltaic module PV+ to the regulator terminal (2)
6. Connect the negative wire of the photovoltaic module PV- to the regulator terminal (3)

Components Technical Specifications					
Lead acid Battery			Photovoltaic module		
Nominal Voltage	12V or 24V (auto detection)		Peak power	150Wp for 12 V _{BAT} 280Wp for 24 V _{BAT}	
Maximum capacity C ₁₀	200 Ah		V _{OC} (open circuit)	50V maximum	
Minimum capacity C ₁₀	60 Ah		I _{SC} (short circuit)	10A maximum	
Technical Specifications - AGNEUS regulator					
Specification	Nominal	Maximum		Minimum	
Battery voltage V _{BAT}	12V / 24V	15V / 30V		10,8V / 21,5V	
Charge current	8,5A	10A		0,01A	
Load current	8A	10A		0A	
Self consumption	2W	3W		0,1W (night)	
Temperature	25°C	60°C		-15°C	
General data - AGNEUS regulator					
Dimensions & weight (width x height x deep)	19mm x 93mm x 71mm			100 gr.	
Kind of regulation	Shunt & Pulse With Modulation (PWM) charge current				
Deep Charge algorithm	4 estates with active control of charge current				
Battery charge control voltages	12 V _{BAT} 24 V _{BAT}	13,5V _{FLOAT} 27V _{FLOAT}	14,4V _{BULK} 28,8V _{BULK}	14,5V _{CONTROL} 29V _{CONTROL}	14,9V _{EQUALIZE} 29,7V _{EQUALIZE}
Charge cycles interval	Minimum 1 day till a maximum of 30 days				
Efficiency	>98% for 12 V _{BAT}			>99% for 24 V _{BAT}	
Night Load Control (Page 3)	Hourly schedule	Lights ON 6h to 8h at sunset		2 hours ON before sunrise	
	luminosity control	100% or 50% (1ms pulses)		Lights OFF if V _{BAT} < 22,4V	
Device protections	Low battery	PV & battery polarity		Overcharge	short circuit
Case protection degree	IP54 AGNEUS regulator				

Night lighting control system saving consumption 50% by dimming lamps

Profile 1. Winter configuration (11h at night or more), SoC = 100% (full charged)

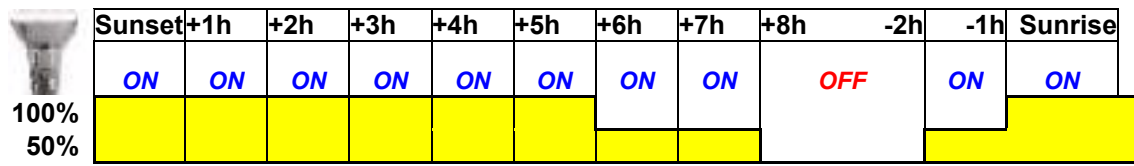

Profile 2. Winter configuration (11h at night or more), SoC = 70%, good HoEC

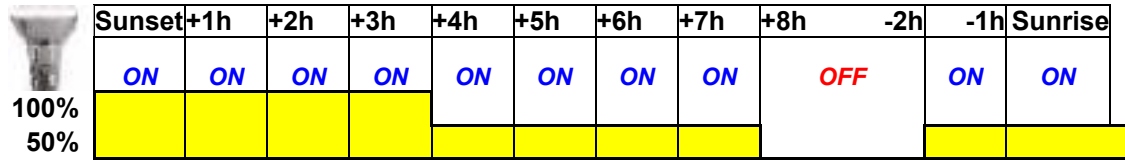

Profile 3. Winter configuration (11h at night or more), SoC = 70%, bad HoEC

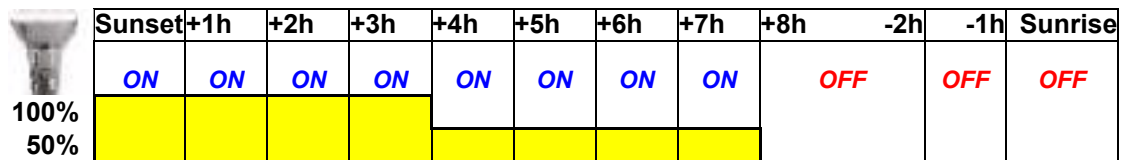

Profile 4. Winter configuration (11h at night or more), SoC = 40% (low battery)

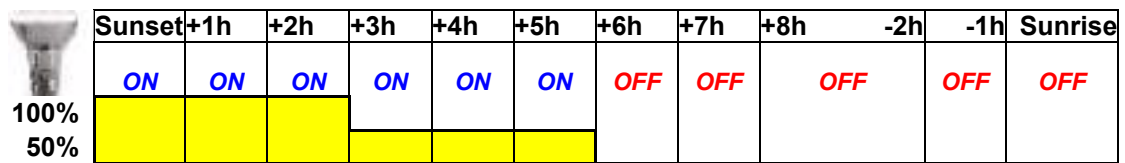

Profile 5. Summer configuration (10h at night or less), SoC = 100% (full charged)

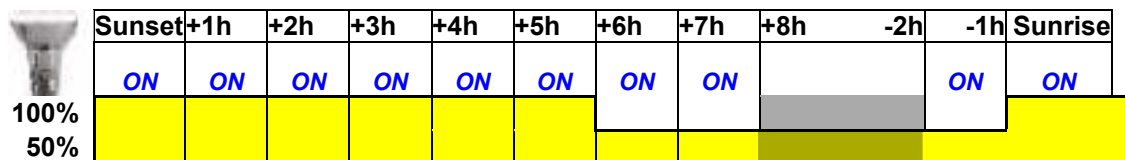

Profile 6. Summer configuration (10h at night or less), SoC = 70%

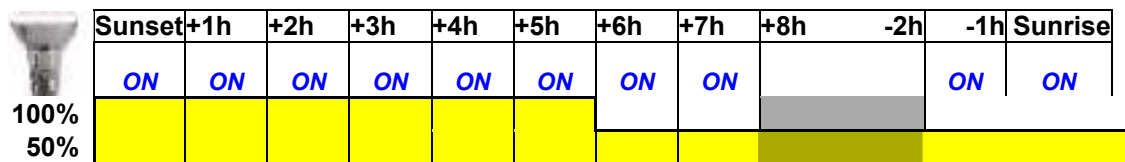

Profile 7. Summer configuration (10h at night or less), SoC = 40% (low battery)

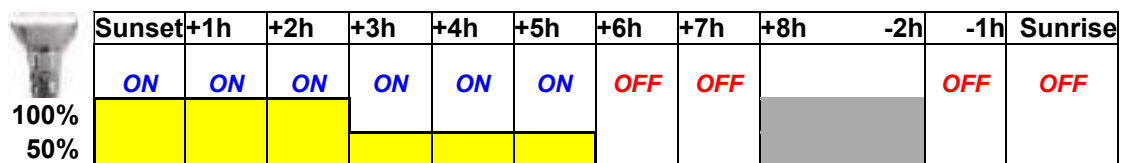

SoC = Battery State of Charge

HoEC = Historical of Equalization Charge or deep charge of battery, measured in number of days from the last equalization.